

INFILCO DEGREMONT WATER + WASTEWATER TREATMENT GUIDE



PRODUCTS

HEADWORKS

Climber Screen® Mechanical Bar Screen	4
Helico® Screenings Press	4
Vortex® Grit Remover	5
Traveling Bridge Grit and Grease Removal System	5

SEPARATIONS

Accelerator® Solids Contact Clarifier	6
AquaDAF® High-Rate Dissolved Air Flotation Clarifier	6
Superpulsator® Pulsed Sludge Blanket Clarifier	7
DensaDeg® High-Rate Clarifier/Softener and Thickener	7
DensaDeg® CSO/SSO Clarifier	8
ABW® Automatic Backwash Filter	8
Greenleaf Filter Control	9
Monoflor® HD Underdrain	9
Ferazur®/Mangazur® Biological Iron, Manganese, and Arsenic Removal	10
PulsaPAK® Package Treatment Plant	10
AccelaPAK® Treatment Plant	11
AquaPAK Package DAF Treatment Plant	11

BIOSOLIDS

Cannon® Mixer Digester Mixing System	12
2PAD Two-Phase Anaerobic Digestion System	12
Thermylis™ High-Temperature Fluid Bed (HTFB) Thermal Oxidation System	13

BIOLOGICAL

Biofor® Biological Aerated Filter	14
METEOR® IFAS/MBBR	14



WORLD-CLASS TREATMENT SOLUTIONS

Infilco provides high-performance water, wastewater, and sludge treatment solutions for any size population and virtually any influent condition. We are involved in every stage of a project, from process design to equipment supply to operations training.

Careful evaluation of each application means our customers receive the most efficient combination of technology and products at the lowest overall cost. Our design engineers look at the entire treatment process to find ways to improve water

supply and control pollution economically.

We handle drinking water treatment and wastewater applications like primary, secondary, wastewater reuse, and stormwater management for municipalities around the country. Industries, too, benefit from our diverse solutions, including physical-chemical treatment, packed-bed demineralization, ion exchange, reverse osmosis, and aerobic/anaerobic biological systems.

MUNICIPAL/DRINKING WATER SOLUTIONS

Infilco provides solutions for any size customer population and virtually any influent condition. Our proven water treatment technologies include high rate clarification, filtration, biological treatment, and disinfection for drinking water applications. Below are some of the products offerings:

- AquaDAF® Clarifier
- DensaDeg® Clarifier/Softener/Thickener
- Superpulsator® Clarifier
- Accelator® Clarifier-Softener
- Greenleaf Filter System
- Monoflor® Nozzle Underdrains
- ABW® Automatic Backwash Filter
- PulsaPAK - Package Clarifier/Filter System
- AquaPAK - Package DAF Clarifier/Filter System
- AccelaPAK® - Package Clarifier/Softener/Filter
- Ferazur®/Mangazur® Filters

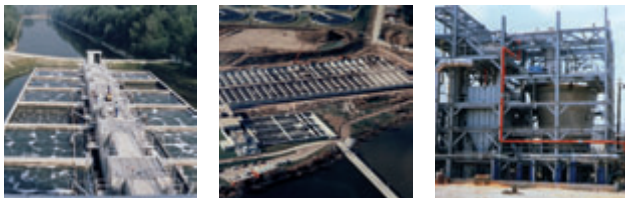

INDUSTRIAL

Infilco designs, engineers, manufactures, commissions and services industrial process water treatment systems. Key industries served include power generation, food and beverage, mining, petrochemical, pharmaceutical, pulp and paper, and refining.

Our solutions include both physical-chemical treatment and biological systems (aerobic and anaerobic). We remove nitrogen, phosphorus and carbonaceous pollution from wastewater, and we treat municipal secondary effluent for industrial reuse as boiler feed water or cooling tower makeup.



WASTEWATER, STORMWATER AND SLUDGE MANAGEMENT SOLUTIONS

Infilco looks at the entire treatment process and finds ways to control pollution efficiently and economically. We handle primary, secondary, wastewater reuse, and stormwater management applications. Our wastewater technologies include headworks, clarification, biological, biosolids and disinfection products, some of which are listed below:

- Climber Screen® Bar Screen
- Vortex® Grit Remover
- Traveling Bridge Grit and Grease Removal System
- Helico® Screenings Press
- Biofor® BAF
- METEOR® IFAS/MBBR
- Cannon® Mixer
- 2PAD Anaerobic Digestion
- Thermylis™ Thermal Oxidation
- ABW® Automatic Backwash Filter
- DensaDeg® Clarifier/Softener/Thickener
- DensaDeg® CSO/SSO Clarifier
- AquaDAF® Clarifier
- Aquaray® UV Disinfection
- OZAT® Ozone



HEADWORKS

PRODUCT FOCUS: CLIMBER SCREEN® Mechanical Bar Screen

Maximize screenings capture; minimize problems

Engineered to last with minimal maintenance, **Climber Screen®** reduces costs and complications in severe-duty applications. A precision, gear-driven cleaning rake carries solids from the bar rack to a discharge chute for removal – without the need for chains, sprockets, or cables that can break. A hinged wiper assembly engages at the discharge point to ensure that the screenings reach the chute instead of returning to the channel. Large obstructions aren't a problem for **Climber Screen®**. The rake will disengage from the bar rack until it clears the object or activate an alarm to reverse the unit before damage occurs. Since all moving parts are kept above the water level, maintenance and repairs are minimal.

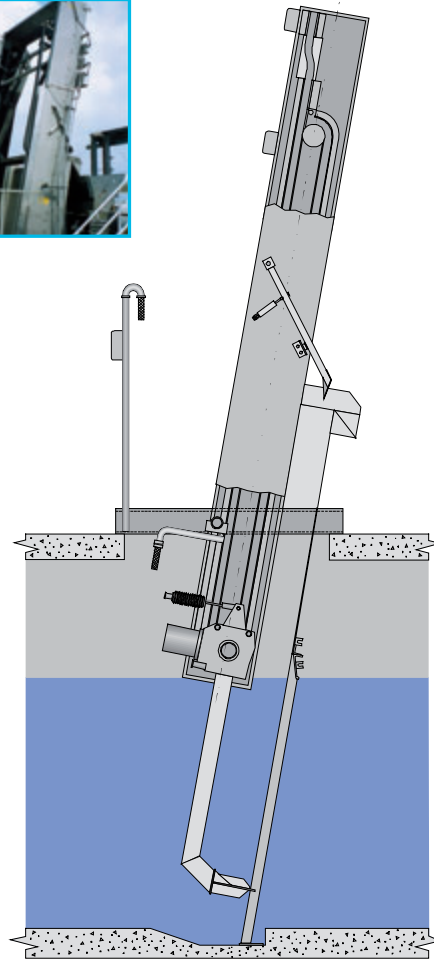

Climber Screen® offers more than 30 years of proven performance

- **Positive screenings** discharge eliminates carryover so you get a cleaner channel in less run time
- **Heavy-duty** gear and pin rack reduces friction and vibration for quiet, trouble-free operation in severe conditions
- All moving parts stay above the waterline to last longer with less maintenance and repair
- **Flexible, durable design** fits any size application – new or retrofit – often without channel modifications
- **Shipped assembled**, or in as few components as possible, for quick and easy installation

Applications

- CSO or stormwater treatment
- Excessive grit or large debris removal
- Deep water and/or low headroom installations
- Raw water intakes

PRODUCT FOCUS: HELICO® Screenings Press

Simple, rugged wastewater reduction

Once wastewater is screened, how can its volume be reduced? The **Helico®** Screenings Press is a natural adjunct to Degremont Technologies' **Climber Screen®** mechanical bar screen. It operates automatically and reduces water content by up to 50%. Screenings are introduced to the **Helico®** Screenings Press through a hopper adjacent to the bar screen. Screenings are conveyed through a compression chamber and then discharged. Extracted water is continuously drained from the tubular compression section and returned to the plant's influent channel. Dewatered screenings exit through a chute and into a removable container or plastic bagging operation.

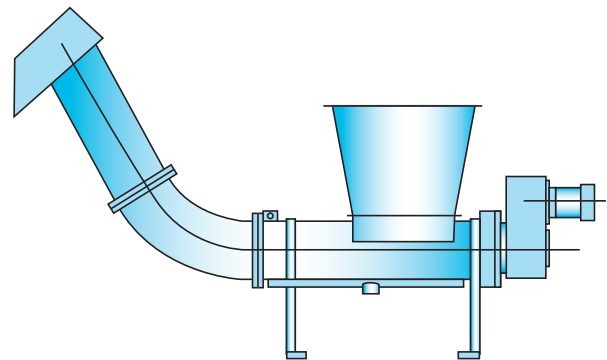

Leave the dewatering to Helico®

- Water content can be reduced to approximately 50%
- Operates automatically
- Reduces volume by up to 60%

PRODUCT FOCUS: VORTEX® Grit Remover

Reduce maintenance costs and troublesome operational difficulties

The **Vortex®** Grit Remover employs a circular tank equipped with a turbine-type rotor to control velocities. Collected grit is pumped to a cyclone concentrator and then to a screw classifier or wedge-wire screen for final separation of the grit from the water. Aeration can be included with the system if the sewage tends to be septic when it reaches the treatment plant. The addition of air to the grit remover tends to mitigate odors and imparts dissolved oxygen to the waste. Air is normally introduced into the **Vortex®** Grit Remover by including a sparger which is located under the rotor.

Protect equipment at municipal or industrial wastewater treatment plants from damage and excessive wear due to abrasion from grit

- **Variable hydraulic** loading optimizes velocity and prevents organic putrescible particles from settling while allowing the grit to be separated
- **Basin geometry** optimizes **Vortex®** performance and eliminates dead spots
- **Variable circulator speeds** obtain the best levels of separation of grit and organic matter in order to meet the specific requirements of each treatment plant
- **With no required overflow weir**, a major source of headloss in the grit remover is eliminated resulting in better plant hydraulics and reduced pumping costs.



Applications

- Municipal Wastewater
- Industrial Wastewater
- Grit Removal

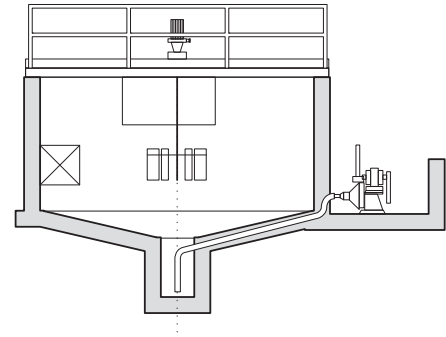

PRODUCT FOCUS: TRAVELING BRIDGE Grit and Grease Removal System

Proven and Efficient

The **Traveling Bridge** Grit and Grease Removal System is designed to reduce horizontal flow velocity to allow heavy particles to settle while grease and other floating substances are allowed to rise to the surface to be separated. An aeration system is utilized to keep the majority of organic materials in suspension during the process. Slower spiral flows at the effluent end allow grease to float. The air mixing and tank equipment adjust to treat significant variations in horizontal flow velocity. Horizontal flow velocity is reduced to allow heavy particles to settle while grease and other floating substances are allowed to rise to the surface to be separated. All moving parts are accessible from the bridge or the walls of the degritter tank.

A proven technology with over 100 installations worldwide

- **An easy and automated process** with low maintenance and a simple rectangular design that is automated and reliable
- **Grit removal** that minimizes abrasion of mechanical equipment and grit/sand accumulation downstream
- **Grease separation** prior to biological and sludge treatment
- **Easily retrofitted** into existing basins

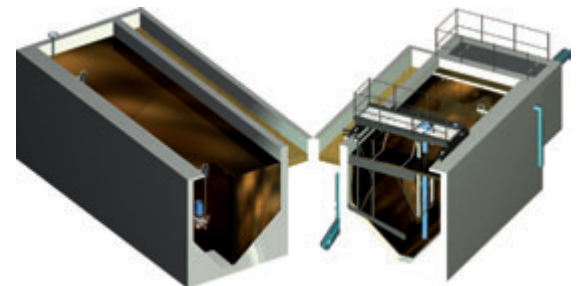

Applications

- Grit and Grease Removal
- New Construction
- Retrofit into most Existing Basins

SEPARATIONS

PRODUCT FOCUS: Accelator® Solids Contact Clarifier

A long-standing treatment plant in a single basin

The Accelator® Clarifier employs the principle of internal slurry recirculation to accelerate physical and chemical treatment processes. Mixing and reaction, clarification, and sludge wasting functions are performed in a single basin that requires less than half the volume of conventional multi-tank systems - making Accelator® an excellent choice when space is an issue. Accelator®'s unique rotor-impeller combination provides directed flow and dynamic solids separation at independent rates to handle rapid changes in water characteristics. Both "NS" model and "IS" model Accelators® are available in steel or concrete basins. The "IS" model, designed for larger plants, includes sludge scrapers and bottom sumps to accommodate higher volumes of sludge.

An original that's often copied, never matched

- Internal sludge concentrators remove excess slurry with less water waste
- Independently adjustable rotor-impeller lets you customize the unit for specific conditions
- Low-volume basin saves space and construction costs
- Uniform slurry concentration produces consistent, high-quality effluent that is less susceptible to upsets in the plant
- Easy to operate: only routine checks of chemical treatment, slurry concentration, and blowdown rate are required



Applications

- Clarification/softening
- Wastewater treatment
- Industrial process and waste
- Water reuse

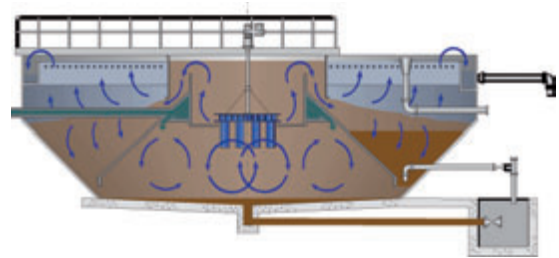

PRODUCT FOCUS: AquaDAF® High-Rate Dissolved Air Flotation Clarifier

Unique concept for unequaled flotation rates

The AquaDAF®'s unique effluent collection system raises dissolved air flotation technology to the next level. Dissolved air flotation (DAF) flocculates and clarifies raw water that has been pretreated with coagulant only, which keeps the process cost-effective and polymer-free. A pressurized recycle stream produces microbubbles that attach to the floc, pushing solids to the water's surface where they can be mechanically or hydraulically removed.

The AquaDAF® collection system creates a unique flow pattern that increases the bubble surface area for increased flotation and loading rates up to ten times greater than conventional DAF systems.

The result: a smaller footprint, reduced energy consumption, lower capital expense, and lower operating costs.

AquaDAF® for clear advantages

- Unique collection system yields unequaled loading rates
- Expanded plant capacity without additional basins
- Polymer-free, low effluent turbidities ensure longer filter runs
- Flexible float removal adapts to plant needs
- Simple design for easy operation and maintenance
- Small footprint results in space savings and lower capital costs
- Hydraulic or mechanical flocculation and float removal



Applications

- Efficient low-density particle removal
- Algae removal
- Membrane pretreatment
- Low to moderate turbidity, high color, high TOC clarification
- Cold water treatment

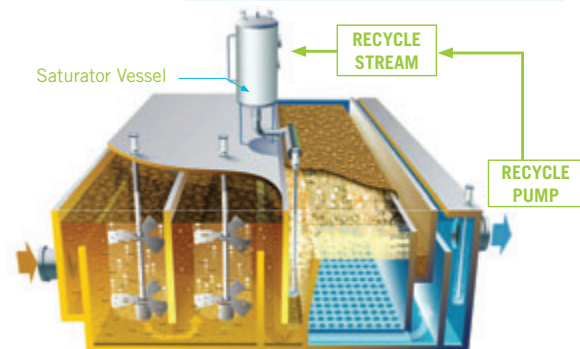

PRODUCT FOCUS: Superpulsator® Pulsed Sludge Blanket Clarifier

Space-saving, high-rate solids contact clarifier

The Superpulsator® combines flocculation and clarification functions in one basin for optimal use of space. Vacuum-generated flow pulsations create a homogeneous sludge blanket that results in excellent effluent quality at minimal operating costs.

The Superpulsator® has demonstrated superior performance with problem surface waters and waters with low to high levels of suspended solids. Ideal for removing color, turbidity, and organic material, the Superpulsator® is fully capable of handling wide variations in influent conditions.

Superpulsator® is proven - delivering improved efficiency and lower costs in hundreds of operating installations

- Combines flocculation and clarification in a single basin for compact footprint, lower construction costs
- No submerged moving parts; all underwater components are corrosion-resistant for minimal maintenance
- Fully automated, requiring little operator attention
- Very low energy consumption compared to other clarification processes

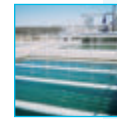

Applications

- Surface water clarification
- Potable water treatment
- Low to high turbidity (1-1,000 NTU)
- Low to high color (1-400 NTU)

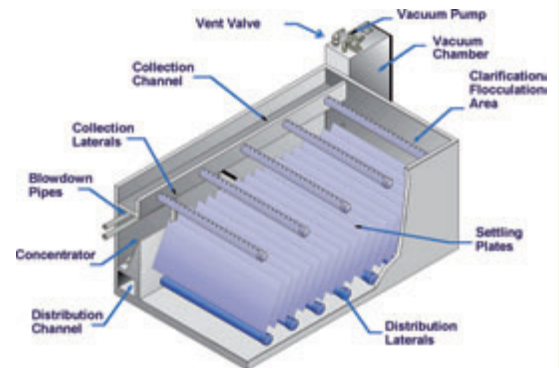

PRODUCT FOCUS: DensaDeg® High-Rate Clarifier/Softener and Thickener

DensaDeg® delivers efficiency with real value

The DensaDeg® is a high-rate solids contact clarifier that achieves unparalleled hydraulic loading rates and treatment efficiencies by combining optimized flocculation, internal and external sludge recirculation, and tube settling in two conjoined vessels.

The DensaDeg® features a blend of energy input and high-volume solids recirculation to reduce waste sludge volume and increase settling rates, optimizing both unit operation and treatment results. Because it clarifies and thickens, DensaDeg® is especially effective when waste sludge volumes are a problem or where there are site constraints.

DensaDeg® is the clear choice for cost-effective solids contact clarification

- Needs about half the space of conventional solids contact clarifiers
- Automatic startup, shutdown, metering, and drawoff control require minimal operator attention
- Reduces startup time and accelerates treatment rates through internal and external sludge recirculation and high reactor solids concentration
- Very dense waste sludge requires less handling and storage
- Hydraulic loading management serves a broad range of flow rates and raw water characteristics
- No abrasive materials are introduced that lead to wear on pumps, mixers, or scrapers



Applications

- Lime softening
- Clarification of surface waters
- Combined clarification and softening
- Tertiary treatment of wastewater (phosphorous removal)
- Industrial applications
- Treatment of filter or membrane backwash water
- Metals removal

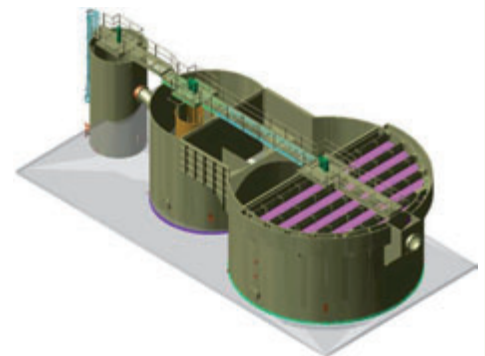

SEPARATIONS

PRODUCT FOCUS: DensaDeg® CSO/SSO Clarifier

Wet-weather clarification and thickening functions in a single, compact unit

DensaDeg® efficiently and economically meets the full range of wet-weather treatment needs. Its high-performance design accommodates a wide range of flow rates, including unusually high peak levels, and combines two fundamental clarification functions in a single unit:

- Integrated coagulation and flocculation followed by tube settling
- Sludge densification and thickening

DensaDeg® CSO/SSO achieves high-rate physical/chemical treatment of wet-weather flows at rise rates as high as 50 gpm/ft² in the settling zone. Solids removal is typically greater than 85% and effluent quality is excellent, exhibiting low SS, COD, and BOD₅.

Combined functions achieve superior efficiency and economy

- Space-saving and efficient with optimized individual functions integrated into one system
- Fast buildup to full capacity and low sensitivity to load variations
- Concentrated sludge production requires no added thickening equipment
- Low operating cost through automatic reagent metering and automatic control of startup, shutdown, and sludge wasting
- Hydraulic loading management enables operation over a broad range of flow rates

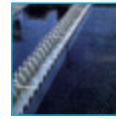

Applications

- Stormwater clarification
- Combined sewer overflows (CSO)
- Sanitary sewer overflows (SSO)
- Primary clarification

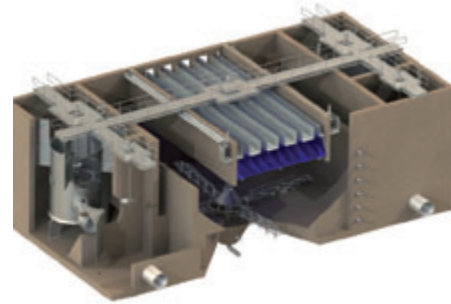

PRODUCT FOCUS: ABW® Automatic Backwash Filter

Exclusive traveling bridge filter performs without downtime

The ABW® Filter operates at low headlosses of just 6 to 12 inches for effective media cleaning with reduced construction, maintenance, and operating costs. A regular, short-duration backwash cleans each cell in the compartmentalized filter bed, so the system uses less water and can remain on line at all times. Our exclusive, seven-stage process introduces backwash water gradually to maintain a consistent media bed for optimum effluent quality.

ABW is the answer for economical, space-saving filtration

- Channel-controlled flow is fully automatic with no complex valves, piping, controllers, or related accessories
- Shallow bed design keeps excavation and construction costs low
- Corrosion-resistant materials last longer with less maintenance
- A patented prewash option injects chlorine prior to backwash, eliminating the possibility of biological growth in the filter cell
- Patented filter-to-waste option meets regulatory requirements for potable water applications
- Leak proof "Quickplate™" underdrain option speeds installation



Applications

- Tertiary treatment of municipal wastewater
- Potable water treatment
- Water reuse (Title 22 approved)
- Industrial process and waste treatment



PRODUCT FOCUS: Greenleaf Filter Control

Compact command center for multiple gravity filters

The **Greenleaf** Filter uses low-maintenance siphon technology to replace bulky piping, valves, pneumatic flow controls, and complex instrumentation for efficient rapid gravity filter control. Multiple cells form a compact arrangement around a central core that controls the filtering and backwash cycles through individual siphon valves. The central unit houses all control functions above the water level for easy operation and maintenance.

The filter is always under a positive head for excellent stability. All flow rates increase and decrease gradually from above the filter media, making it impossible to shock or surge the filter.

Greenleaf keeps your system simple, flexible, and accessible

- Operates at the same rate as a conventional filter in only two-thirds of the space
- Fewer moving parts require less maintenance
- Common wall construction with **Superpulsator**® results in a compact, cost-effective water treatment plant
- The clearwell does not require deep excavations or support structures, greatly reducing costs
- Simple design provides easy access to all controls in one central location



Applications

- Conventional filtration applications
- Limited-space configurations
- Tertiary filtration
- Industrial process water

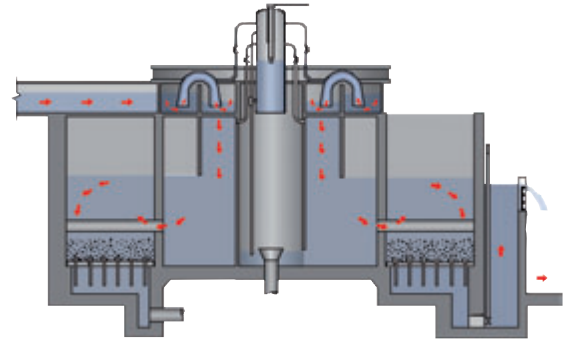

PRODUCT FOCUS: MONOFLO[®] HD Underdrain

Air scour cleaning power with superior structural strength

The **Monoflor**® HD Underdrain incorporates the proven efficiency of both air and water backwash in a single, poured-in-place concrete unit.

By eliminating precast concrete components, the **Monoflor**® provides superior structural strength without the need for sealants or the shipping, storage, and handling costs associated with precast systems.

A high impact, molded polystyrene form containing the nozzle adapters becomes a permanent part of the unit once the concrete is poured. A high concentration of nozzles provides more even distribution of backwash air and water.

Key advantages over other underdrain systems

- A single pour of concrete
- High-impact polystyrene forms
- High nozzle concentration
- Six standard pressure loadings

Applications

- Single or multimedia applications
- High particulate-level water
- Drinking water treatment
- Industrial filtration
- New and rebuilt water systems



SEPARATIONS

PRODUCT FOCUS: Ferazur®/Mangazur® Biological Iron, Manganese, and Arsenic Removal

The biological alternative to conventional removal of metals

Ferazur®/Mangazur® employs naturally occurring bacteria to accelerate the oxidation rate and removal of iron, manganese, and arsenic. The precipitate is removed using Biolite™ “S,” our specially developed inert filter media that requires no periodic replacement. The bacteria remain in the filter media even after backwashing, allowing continual operation for indefinite time periods.

This biological process yields filtration rates of up to 20 gpm/ft², depending on raw water quality. Compact and easy to operate, the prefabricated unit is ideal for small communities or to retrofit existing plants.

Process advantages make Ferazur®/Mangazur® the natural choice

- Lower capital and operating costs through the elimination of chemicals, less frequent backwashing and maintenance, and reduced filter size
- Higher metals retention on the Biolite™ “S” allows longer filter runs
- Requires less water for backwashing
- Water quality does not deteriorate over time as in some conventional greensand systems
- Environmentally friendly process requires no oxidizing chemicals



Applications

- Iron, manganese and arsenic removal
- Groundwater treatment
- Gravity or pressure filters

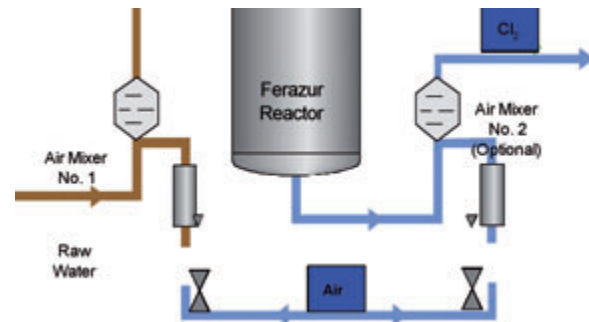

PRODUCT FOCUS: PulsaPAK® Package Potable Treatment Plant

Complete range of treatment capabilities in a compact package plant

PulsaPAK® produces superior-quality drinking water thanks to two proven technologies: the Pulsator® Clarifier with tube-settling modules and a dual media gravity filter. This system's innovative use of basic water chemistry principles addresses a wider range of treatment issues than conventional package plants. The PulsaPAK® provides not only flocculation and filtration of solids, but also treats the turbidity and color often found in raw water supplies.

PulsaPAK® – just 10 feet wide and 12 feet high with length varying according to flow rate – requires minimal space, yet its six standard sizes can handle flows ranging from 100 to 700 gpm. With its reliable process stability, PulsaPAK® meets all potable water production guidelines.

Optimized to meet the needs of municipalities and industry

- Compact size, proven technology, competitively priced
- Two-stage treatment process produces excellent-quality drinking water
- Available in six sizes from 100 to 700 gpm.
- Easy installation and startup
- Clarifier has no submerged moving parts that require maintenance

Applications

- Drinking water clarification and filtration
- TOC and color removal



PRODUCT FOCUS: AccelaPAK® Treatment Plant

Customize a compact treatment system to your needs

The **AccelaPAK®** combines all the necessary components for clarification or softening and filtration in a single, compact system. This constant-rate treatment system incorporates a raw water controller, high-rate solids contact softener-clarification unit, filters, and chemical feeders. The **AccelaPAK®**'s modular design is based on a system of interchangeable components. This practical and economical approach allows a variety of combinations to meet a range of treatment and operational requirements. Capacities range from 30 to 350 gpm.

Configure AccelaPAK® to your specifications, your facility, your application

- Potable water and service water treatment of well, surface, municipal or industrial or reuse applications
- Advanced wastewater treatment for the reduction of suspended solids, phosphorus, and other contaminants
- Removing heavy metals from industrial wastewater
- Engineered for ease of installation, economy, dependability

Applications

- Small communities, subdivisions
- Industrial plants
- Resorts and parks

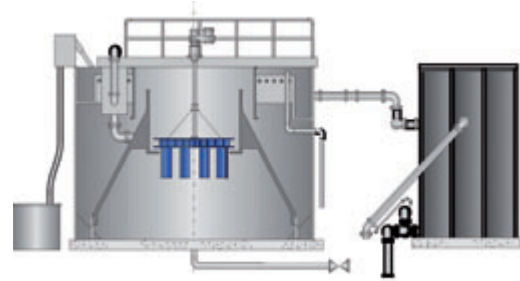

PRODUCT FOCUS: AquaPAK DAF Package Potable Treatment Plant

Complete range of treatment compatibilities in a compact package plant

The **AquaPAK** produces superior-quality water thanks to two proven technologies:

The **AquaDAF®** clarifier and a dual media gravity filter. This system's innovative use of basic water chemistry principles addresses a wider range of treatment issues than conventional package plants.

AquaPAK provides not only flocculation and filtration of solids, but also treats the turbidity and color often found in raw water supplies.

AquaPAK - just 10 feet wide and 12 feet high with length varying according to flow rate - requires minimal space, in many sizes that can handle flows from 50 gpm to 2.5 MGD. With its reliable process stability, the **AquaPAK** meets guidelines for most water treatment applications.

Optimized to meet the needs of municipal and industrial clients

- Compact size, proven technology, competitively priced
- Two-stage treatment process produces excellent-quality drinking water
- Nine standard sizes from 50 to 1,750 gpm
- Easy installation and startup

Applications

- Clarification and thickening
- TOC and color removal
- Algae removal
- Tertiary treatment



Product Focus: Cannon® Mixer

The high-rate mixer that stands above other systems

Peak digester performance and reduced operating costs are directly associated with the use of Cannon® Mixer. Ideal for deep-tank mixing, the system is not only superior in performance but is also easy to install, operate, and maintain.

Based on computerized modeling, multiple Cannon® Mixer units are strategically arranged to optimize mixing zones across the entire digester floor, keeping full volume in suspension with little deposition of solids. Large piston bubbles – proven as the most efficient use of energy for fluid displacement – agitate digester contents thoroughly and economically. Bubble generation every three-to-four seconds per mixer guarantees better than 90% active volume in the digester. In addition the large bubbles prevent scum buildup by their turbulent breaking action at the surface.

Cannon® Mixer's distinct advantages can bolster nearly any digester installation

- Low overall energy requirement reduces operating costs by up to 50%
- No submerged moving parts means easy installation and maintenance
- Complete tank mixing means less scum formation, less solids settling, and superior volatile destruction
- Optional heating jackets eliminate the need for expensive external heat exchangers and pump systems

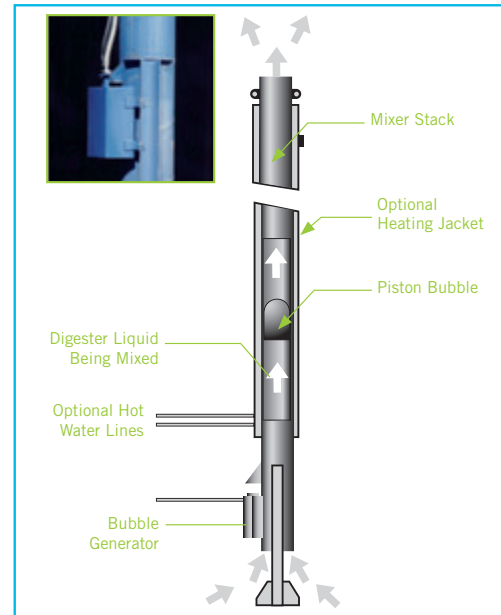

Applications

- Municipal or industrial waste
- Deep-tank mixing of high-viscosity liquids
- Two-phase anaerobic digestion systems

Product Focus: 2PAD Two-Phase Anaerobic Digestion System

Innovative, cost-effective, EPA-certified sludge management

The unique 2PAD Two-Phase Anaerobic Digestion System produces Class A biosolids, which are EPA-approved for unrestricted land application. This innovative process separates the acid- and methane-forming digestion phases, increasing the efficiency of both, and adds high temperatures that destroy pathogens to below detectable limits.

A two-year pilot study confirmed the effectiveness of 2PAD in meeting EPA requirements for Class A biosolids. The system has been granted Conditional National PRFP Equivalency by the EPA.

Ideal for new or retrofitted sludge management facilities, 2PAD offers these benefits:

- Produces biosafe Class A biosolids, EPA-approved for unrestricted land application
- Separates acid- and gas- forming phases for unmatched efficiency and effectiveness
- Lower hydraulic retention time and no aeration mean substantially lower costs
- Virtually no foaming

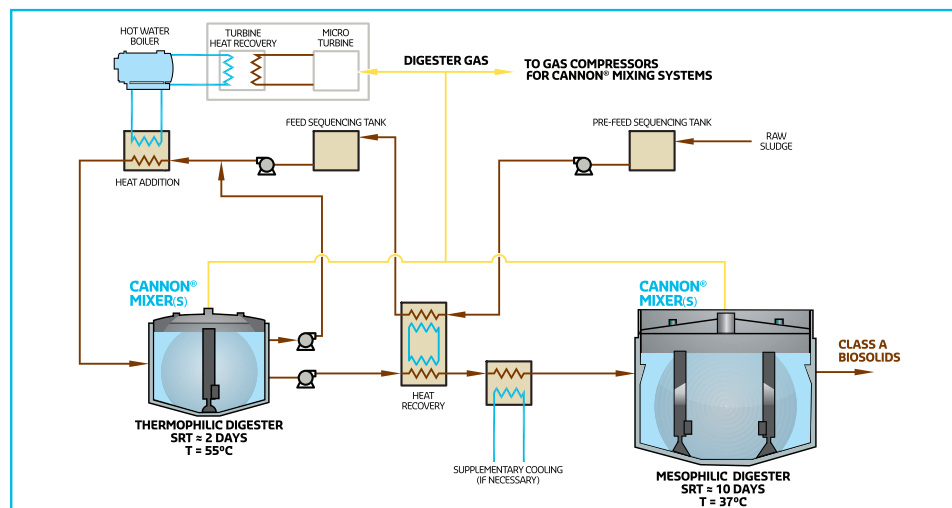

Applications

- Land-applied municipal sludge

Product Focus: Thermylis™ High-Temperature Fluid Bed (HTFB) Thermal Oxidation System

The leading choice for safe, cost-effective fluid bed incineration

The Thermylis™ HTFB system is an economical, environmental solution to conventional incineration. Our process introduces dewatered sludge directly into a hot fluidized sand bed where it is instantly combusted. Escaped gas from the bed flows into a freeboard reaction chamber where it is completely combusted. High-heat transfer and intensive mixing in the fluid bed layer creates a uniform thermal-oxidation process. The large sand mass protects the system against rapid temperature fluctuations for a steady and safe operation.



Clean Technology:

- Simple design destroys all combustibles and pathogens while eliminating the environmental hazards of conventional systems
- Odor free with maximum sludge weight reduction by 93%
- Flexible and easy to operate
- Automated controls minimize operating labor and maintenance costs
- Autogenous combustion and net electrical energy production

Applications

- Municipal wastewater solids
- Pharmaceutical waste
- Chemical and paper waste
- Petrochemical waste

THERMYLIS™ HTFB Thermal Oxidation System

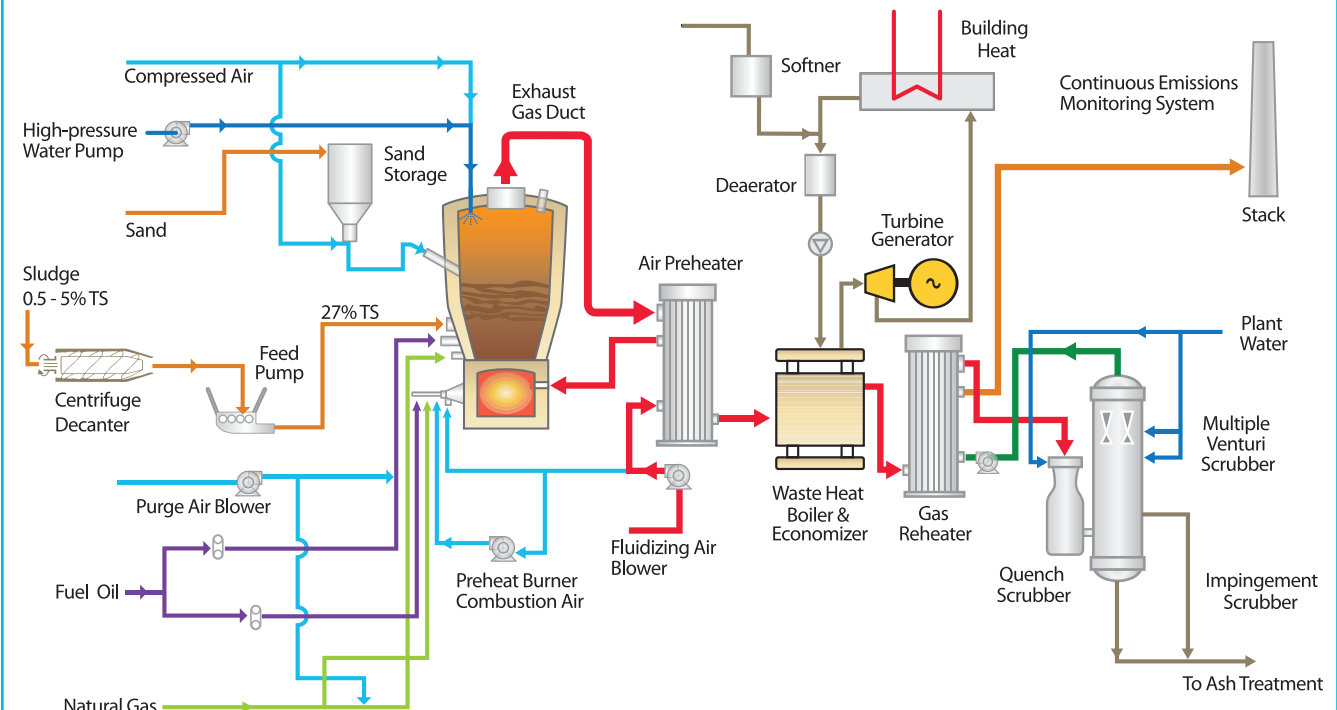

BIOLOGICAL

PRODUCT FOCUS: BIOFOR®

Compact, advanced, environmentally friendly wastewater treatment

BIOFOR® is a submerged biological filter that combines biological water treatment with solids filtration in a high-efficiency, high-rate system. BIOFOR®'s compact footprint and uncomplicated retrofitting make it an excellent solution for new or existing plants where real estate is at a premium. Apply BIOFOR® individually or in separate stages for greater flexibility. Multiple treatment cells reduce energy costs and enable easy upgrades. On-duty cells can operate at optimum filtration rates while off-duty cells are in a backwash cycle or idle mode. Simply add more cells to increase capacity and upgrade capability.

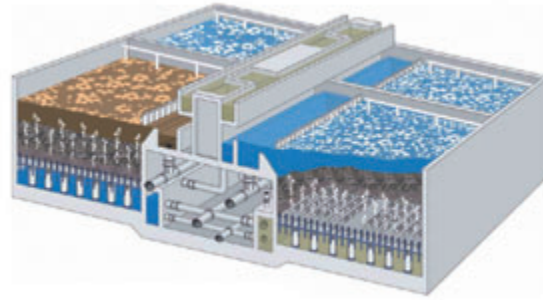

Applications

- Carbonaceous BOD reduction, nitrification, denitrification, total suspended solids removal
- Cold temperature wastewaters
- Tertiary treatment for nutrient removal
- Reuse



BIOFOR® saves time, space, and money

Biolite™ media serves as both biological support and filter, eliminating the need for final clarification. Co-current air and water up flow yields significantly higher loading capacity, with increasing efficiency as filtration rates rise. Systems are completely automated, requiring only routine monitoring to save man-hours and money. Community-friendly and virtually odor-free; with treated water always above the media bed, odors are minimized.

PRODUCT FOCUS: METEOR® IFAS/MBBR

Optimize process performance while minimizing energy and chemical costs

The METEOR® IFAS/MBBR processes are designed to offer flexible solutions to a multitude of biological process upgrade applications such as nitrogen removal, treatment capacity increase and wastewater reuse. An upgrade often consists of simply adding the biofilm media and screens to existing basins and can therefore be completed in a cost-effective and timely manner without major civil engineering requirements and no need for additional land. Based on proprietary polyethylene biofilm carriers, the media technology provides a large internal surface area for the growth of micro-organisms. A 22mm diameter carrier offers the ability to utilize a larger screen mesh size, minimizing headloss across the screen and the tendency to foul. The combination of large aperture area, high specific biomass, and UV resistance makes METEOR® well suited for IFAS or IFAS/MBBR applications.

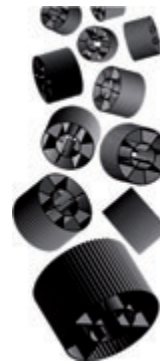

An easy-to-implement and cost-effective way to upgrade

- **Increase capacity** of activated sludge basins by 100% to 200% with an in-basin retrofit
- **Reduce solids loading** on the clarifiers due to reduced suspended growth MLSS after a retrofit
- **Long service life** even in open basins exposed to constant sunlight
- **Prevention and resistance** of clogging tendencies thanks to larger apertures on the biofilm media
- **Reduce headloss** due to larger media size that allows installation of screens with larger openings
- **Compatible** with both coarse and fine bubble aeration

Applications

- BOD removal enhancement
- Nitrification for ammonia removal
- Total nitrogen removal
- Total nitrogen and phosphorous removal

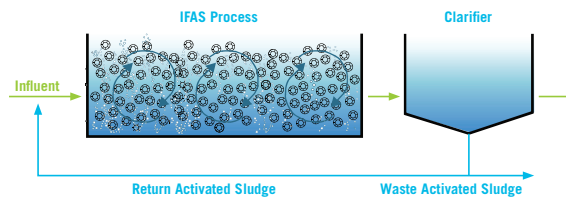

BIOLOGICAL

Fixed Film
IFAS/MBBR

SEPARATIONS

Filtration
Clarification/Softening

Class A BIOSOLIDS

Safe
Environmentally Friendly



SKILLS AND EXPERTISE/PILOTING

Screening HEADWORKS

Grit & Grease Removal

PILOTING

Infilco offers pilot systems and services for the equipment in this brochure as well as many of our other product offerings. Pilot studies are a practical means of optimizing physical-chemical and biological process designs and offer the client several benefits, such as:

- Proof of system reliability
- Optimization of design conditions for the full-scale system
- Regulatory approval
- Familiarize plant staff with operational requirements

If you are interested in a pilot system, please contact us for a proposal.

DENARD

Degremont Technologies-North American Research & Development Center

In North America, the Degremont Technologies North American Research & Development Center (DENARD) provides technical support services and research. In conjunction with Degremont's central research center in Europe, DENARD scientists develop innovative technologies that comply with ever-changing environmental regulations and standards.

DENARD serves as a liaison with federal, state, and university organizations in addressing contemporary environmental issues. Research teams with maximum expertise in their respective fields achieve practical, economical solutions to water and wastewater challenges in North America.

Laboratory Analysis

DENARD's laboratory scientists develop essential data and information needed to solve problems connected with all types of waters. Laboratory analysis plays a major role in the development of Infilco process designs and in the support of pilot plant testing. Staff members assist with process start-up and troubleshooting in the field.



INFILCare®

Parts Sales

Infilco sells parts and components for most INFILCO brand equipment as well as parts for demineralizers, thickeners, nozzles, pressure filters, and valves. We offer reliable spare parts at competitive prices. We maintain records of previous installations to quickly identify your requirements. Many items are shipped directly from stock for quick delivery.

Rebuilds, Retrofits and Upgrades

Infilco offers cost-effective rebuilds and upgrades for INFILCO-provided systems, no matter what year they were built. If you are interested in an economical alternative to installing a whole new system, contact us for a proposal.



INFILCO DEGREMONT INC.

8007 Discovery Drive
Richmond, VA 23229 USA
Tel: +1 804 756 7600
Fax: +1 804 756 7643
info-infilco@degtec.com

www.DEGREMONT-TECHNOLOGIES.com

