

Digital simplicity: Festo Motion Terminal VTEM

FESTO

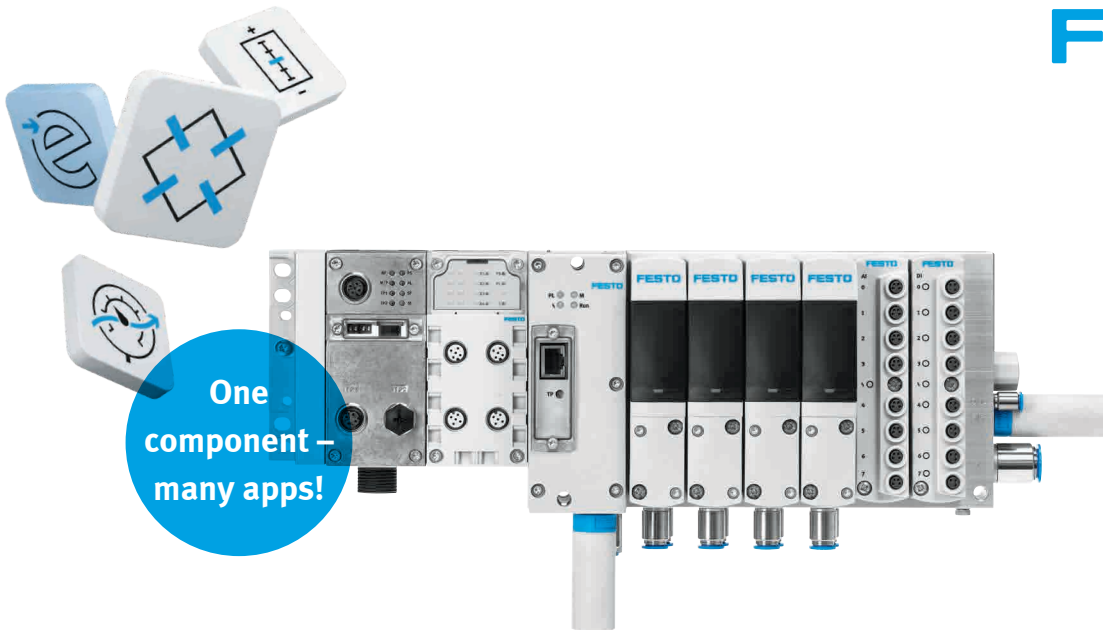

Digitised pneumatics!

Highlights

- Many functions in a single component – thanks to apps
- Combines the advantages of electric and pneumatic technologies
- Highest possible level of standardisation
- Reduced complexity and time-to-market
- Greater profitability and knowledge protection
- Less installation work
- Increased energy efficiency

The Motion Terminal VTEM is opening up radical new dimensions in the world of automation, as it is the world's first valve to be controlled by apps. The first product to truly earn the label "digitised pneumatics". For a multitude of functions that currently require more than 50 components.

Festo Motion Terminal – discover the new world of pneumatics.

Standardise – and still be fit for Industry 4.0

Standardise your production and still delight your customers with highly individual products. Our Motion Apps allow you to integrate a huge range of functions that can be changed at the push of a button without changing the hardware. This enables you to produce customised consumer goods more economically and more easily than ever before – even for batches of 1. From simple valve functions to Soft Stop and proportional pneumatics, VTEM covers all the pneumatic functions you need for your production.

Outstanding energy and economic efficiency

The Festo Motion Terminal uses an integrated concept to ensure energy-efficient operation. In addition to apps for saving energy, low-energy piezo valves have been developed for controlling the main valve stages. These reduce the power consumption for the pilot control by up to 90%, while using just a single valve variant reduces process costs from the design to the modernisation stage.

Discover a new level of flexibility – one piece of hardware for all functions!

Combining numerous functions with the same hardware – this can now be done for the first time ever with the VTEM. No modification, no additional parts, no arduous installation: none of that is needed any more. With the matching Motion App, you can change functions at the press of a button, whether for a simple change in the directional control valve functions, gentle travel in the end positions, energy-efficient movements or proportional characteristics of the motion profiles. That is how the Festo Motion Terminal combines the benefits of both electric and pneumatic automation.

A wide range of products, functions and complete solution packages are integrated into the Festo Motion Terminal. One valve technology, a powerful controller and smart apps: this combination heralds a new era in terms of flexibility.

The apps are the key to almost limitless function integration in valve terminals.

This approach will:

- Reduce the complexity of your systems
- Speed up your engineering processes
- Enable you to continuously and flexibly adjust your machine throughout its entire lifecycle

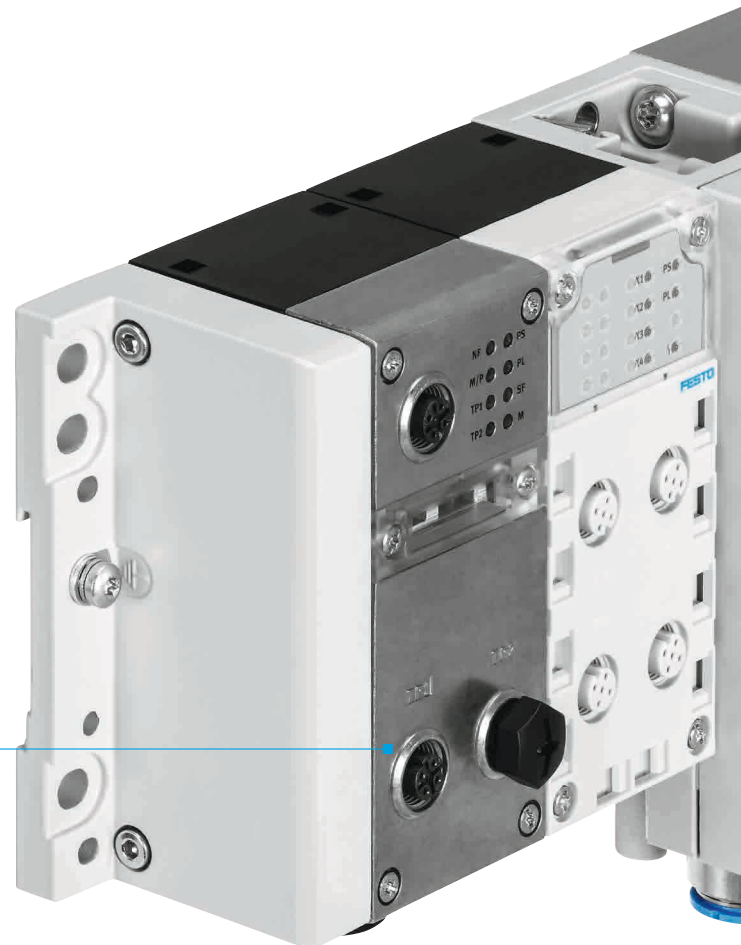

CPX module

CPX supports all standard bus protocols. This gives you the option of using many different controllers and end user specifications, as well as all the usual digital and analogue input/output modules. An integrated CODESYS controller and OPC-UA for Industry 4.0 are available on request.

CPX-CTEL

The installation system allows you to integrate up to 4 standard valve terminals cost-effectively as no extra bus nodes are required. This makes combining different technologies effortless.

Ethernet WebConfig interface

When it comes to efficient parameterisation the choice is yours: you can either use an intuitive WebConfig user interface via the PC's web browser or easily access the (PLC) machine control system as usual – without the need for additional configuration software.

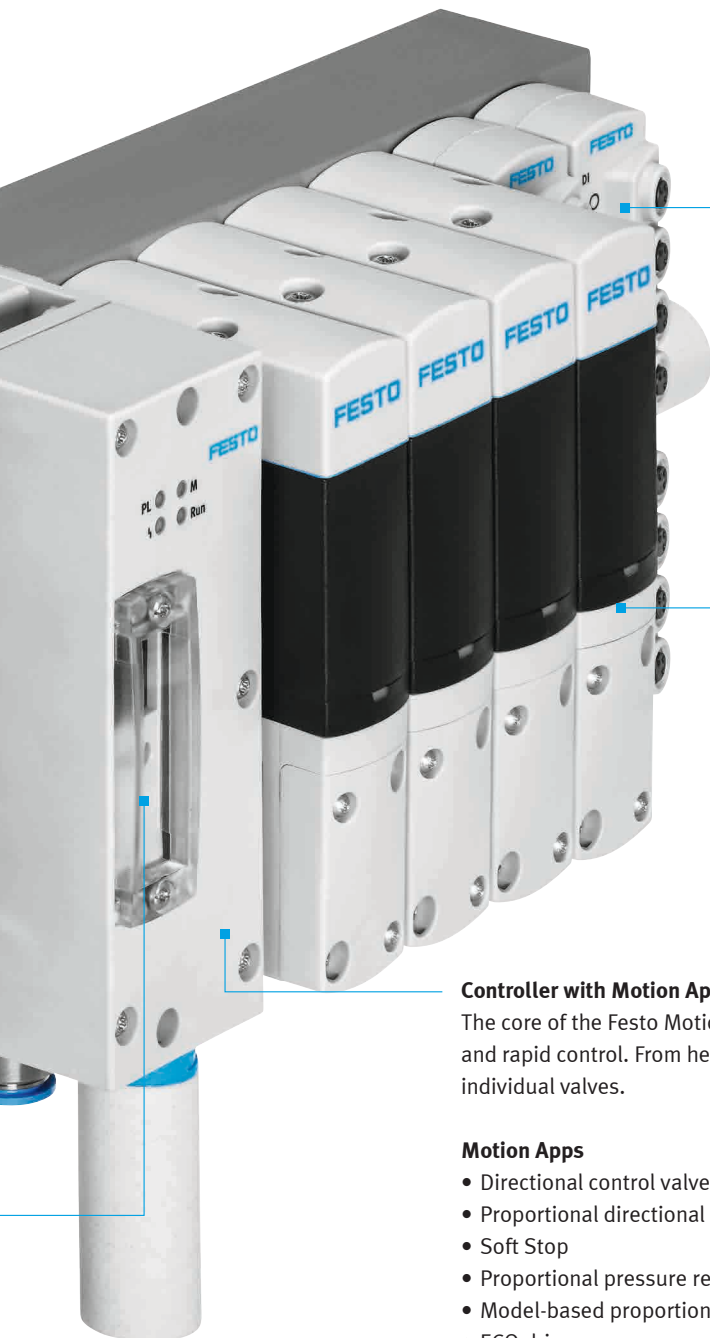

Input module

Up to 16 analogue or digital inputs for direct control applications such as Soft Stop. The necessary data is recorded and transmitted by sensors mounted directly on the actuator.

Valve

The app-controlled valve comprises four 2/2 diaphragm poppet valves, which are controlled by four piezo pilot valves. The integrated stroke and pressure sensors provide optimal control and transparent condition monitoring.

Controller with Motion App

The core of the Festo Motion Terminal offers decentralised intelligence and rapid control. From here, the motion apps are assigned to the individual valves.

Motion Apps

- Directional control valve functions
- Proportional directional control valve
- Soft Stop
- Proportional pressure regulation
- Model-based proportional pressure regulation
- ECO drive
- Selectable pressure level
- Leakage diagnostics
- Supply and exhaust air flow control
- Presetting of travel time

Important: Please check the availability in your country at:
→ www.festo.com/motionterminal

Revolutionary: one valve technology for a huge range of functions

The new valve technology of the Festo Motion Terminal can be used for a wide range of products, functions and complete solution packages. The only prerequisite is a valve design with multiple degrees of freedom for actuation, as well as integrated data acquisition and processing suitable for a cyber-physical system. The reduction to just 1 valve variant provides both system builders and operators with huge economic benefits.

Bridge circuit in the valve

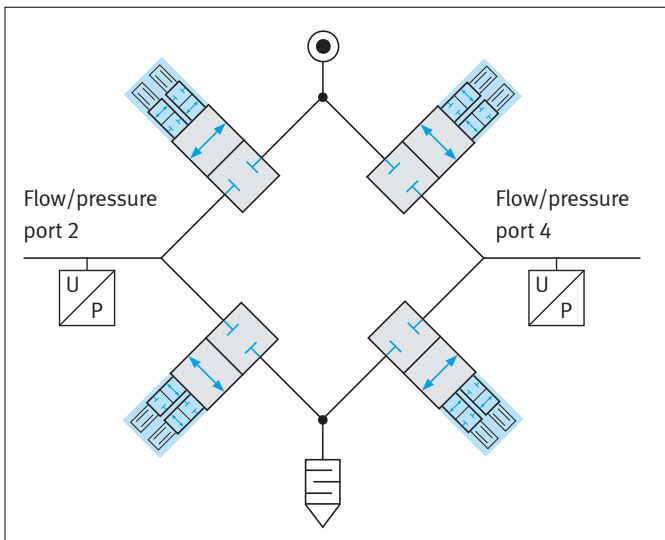

Piezo pilot valve



2x 2/2-way valves in one cartridge

Diaphragm poppet valve



1 valve variant: a single valve replaces over 50 individual components

The bridge circuit in the valve of the Festo Motion Terminal is an innovative valve system that is based on the basic elements of pneumatic valve functions.

- Four 2/2-way valves (diaphragm poppet valves) are connected in series to form a full bridge
- Each diaphragm poppet valve (grey) is proportionally piloted and controlled by two piezo valves (blue)
- Sensors monitor the stroke of each poppet valve, while pressure sensors monitor the pressure at ports 2 and 4.

All four pilot cartridges (blue) form a total of eight proportionally controlled 2/2-way valves. Thanks to the integrated sensors and proportional control, which allows the valves to be pressurised and exhausted independently, this single valve technology can now be used to execute a wide range of conventional valve

functions and full system solutions, such as Soft Stop.

From simple directional control valve functions to complex motion tasks

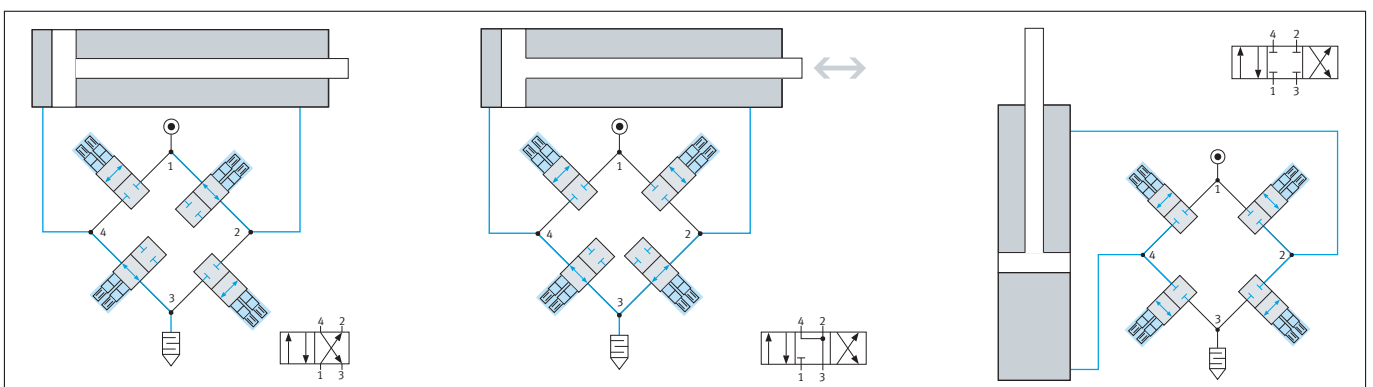

Valve electronics with sensors
Stroke, pressure and temperature sensors provide optimal control and transparent condition monitoring.

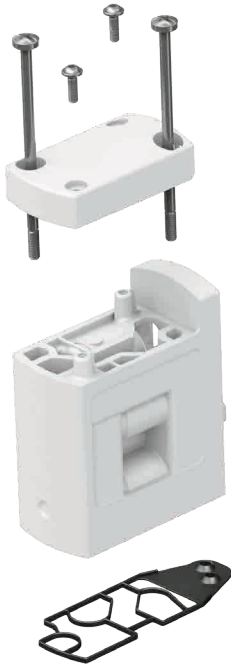

Four diaphragm poppet valves
Actuating the poppet valves individually enables a high degree of flexibility.

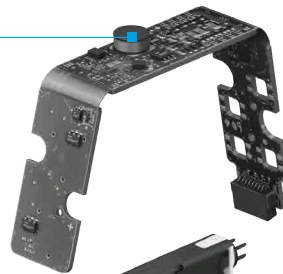

Four piezo pilot valves
Extremely short switching times, low power consumption, sturdy and durable technology.

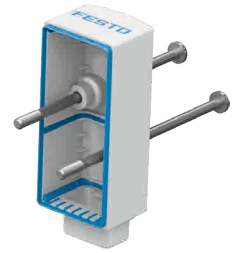

Self-learning and adapts autonomously

Every valve slice in the Festo Motion Terminal has analogue pressure and stroke position sensors that continuously exchange their data with the controller. This enables the system to run its own evaluations and make its own decisions. This means, for example, that external load cells are no longer

needed for status monitoring during pressing procedures. The combination of integrated sensors and software-based models not only saves money, it also simplifies system engineering, from design to modernisation.

This is how piezo technology works

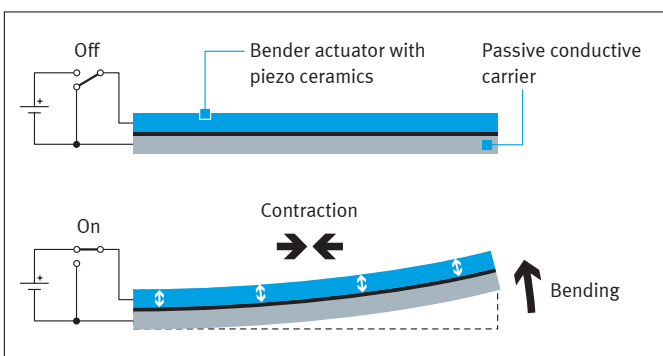

The advantages of piezo valves

- High-precision, continuous control
- High energy efficiency thanks to incredibly low power consumption
- No operating noise
- No heat build-up
- Extremely long service life with more than 300 million switching cycles

Flexibility and standardisation, hand in hand: our Motion Apps

The Festo Motion Terminal offers you benefits throughout the entire value chain, from the design to the modernisation of your machine. The Motion Apps, which control a single piece of hardware, are an integral part. They allow you to standardise your applications while offering unparalleled levels of flexibility. The result: huge savings and increased productivity. More apps are already being planned.

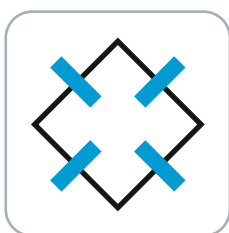

Directional control valve functions

Maximum flexibility for special-purpose machines as well as for handling systems in series production. You can modify standard directional control valve functions such as 4/2, 4/3 and 3/2 at any time and as often as necessary, even during operation. This enables you to respond to a large number of requirements at the touch of a button.

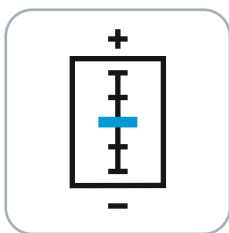

Proportional directional control valve

For the first time at Festo, two proportional flow control functions have been integrated in one valve and on one platform, resulting in an economical and compact solution.

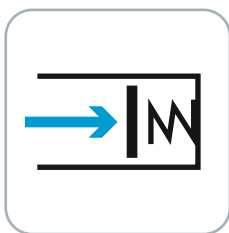

Soft Stop

Shorten your cycle times by up to 70%! With Soft Stop, you can implement highly dynamic yet gentle positioning motion without wear-prone shock absorbers. This reduces maintenance times, increases the service life of your system and thus enhances your productivity. (Required accessory: position sensor SDAP)



Proportional pressure regulation

Save space and hardware costs by combining the functions of two individual and independent proportional pressure regulators in just one valve – including with vacuum!



Model-based proportional pressure regulation

With model-based control, there's no need for external sensors. By storing fewer boundary parameters for the system, such as tube length, tube diameter and cylinder size, the anticipatory control system ensures maximum accuracy, as the app can compensate for a drop in pressure and volume using the control technology.



ECO drive

Reduce costs by operating your actuator with the minimum pressure necessary for the load. This eliminates the rise in pressure in the drive chamber at the end of the movement, allowing energy savings of up to 70%. With a single DSBC32-100 with a 2 kg load, this is a saving of approx. €100 a year. (Required accessory: cylinder limit switch)

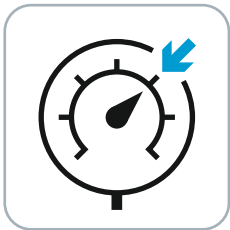

Selectable pressure level

Save energy by setting several pressure levels. Simply set the pressure for the selected movements to a level of your choice. Additionally, you can control the speed by adjusting the flow control valve setting.

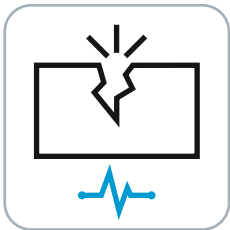

Leakage diagnostics

Fewer system downtimes and faster fault detection due to preventive maintenance. Separate diagnostic cycles and defined threshold values enable you to detect and localise individual leaks in the application operated by the Festo Motion Terminal.

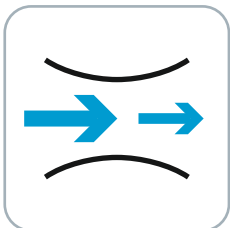

Supply and exhaust air flow control

Do away with separate flow control valves on the actuator and set tamper-proof travel speeds quickly and conveniently at the touch of a button. There is also an option to implement new motion sequences such as dynamic flow control adjustment.



Presetting of travel time

For quick and easy commissioning and stable operation, all you have to do is enter the travel time for the advancing and retracting motions. The exhaust air flow control function adapts itself to the travel time and then maintains it. The system automatically adjusts the values in the case of influences such as increased friction due to wear. (Required accessory: cylinder limit switch)

This is how it works: selecting Motion Apps

You can order the Festo Motion Terminal via the Online Shop, just like you would normally order a valve terminal. The familiar configuration interface now has several new features, including selection and purchasing of the necessary Motion App licences, which are then saved to the controller before it is shipped out. The “Directional control valve functions” Motion App licence is always included in the basic configuration.

Motion Apps: available licences

The Motion Apps which we offer as licence packages or as multi-valve apps can be used without restriction for all valve positions of the Festo Motion Terminal. Licences for individual apps, on the other hand, need to be purchased for each valve function used. The valve position

can be freely selected and changed as required. For example, if you need two proportional pressure regulator functions at the same time, you will need to buy two Motion App licences. Alternatively, you can adjust the schedule for your process so that the

functions are used in sequence, one after the other. All licences are linked to a particular Motion Terminal and cannot be transferred to other Motion Terminals.

Basic package

However you configure your Festo Motion Terminal, with four or eight valves, with or without digital/analogue input modules, the Motion App licence “Directional control valve functions” is always included with the hardware for all valve positions – at no extra cost!

- Motion Terminal
- Directional control valve functions



Start package

The start package includes the licences for the main, basic pneumatic functions for all valve positions. It can be used to execute a huge number of tasks. These apps are only available as part of this package.

- Selectable pressure level
- Supply and exhaust air flow control
- Proportional directional control valve



Multi-valve apps

With these apps, you can expand the range of functions for all valve positions. They can be bought individually.

- Leakage diagnostics
- ECO drive
- Presetting of travel time



Single-valve apps

These apps also expand the range of functions but only for a single valve position. These apps are available individually.

- Proportional pressure regulation
- Model-based proportional pressure regulation
- Soft Stop



Downloading Motion Apps

Do you need another app now that your Festo Motion Terminal has been delivered? Simply download it from our App World using the Product Key! → www.festo.com/appworld

Important: For the ECO drive, Presetting of travel time and Soft Stop Motion Apps, you will need the fast input module CTMM and other sensors from the range of accessories for the Festo Motion Terminal.

Festo Motion Terminal: digitised pneumatics for Industry 4.0

Intelligent cyber-physical systems (CPS) with appropriate software/apps are a key part of Industry 4.0. With the right interfaces, CPSs can communicate with one another and execute processes autonomously. The apps in the Festo Motion Terminal allow a level of function integration unlike any seen before. In the future, only one piece of hardware will be needed and changes can be made at the push of a button. This will enable you to create systems for a batch size of 1.

Digitised pneumatics

The digitalisation we are experiencing as part of Industry 4.0 will profoundly alter the world of production. Thanks to its intelligent fusion of mechanics, electronics and software, the Festo Motion Terminal can be developed into a “cyber-physical system”. The system allows maximum adaptability and flexibility, as its integrated sensors provide process transparency and options for self-optimisation and self-adaptation to external

influences. The product key that represents the digital copy of your unit and the optional OPC UA interface for Industry 4.0 round off this range of features.



The benefits of Industry 4.0

Adaptability for greater productivity

- Change formats using parameter records and modify apps/functions during operation
- Process reliability is guaranteed thanks to self-regulating, autonomous adjustment, e.g. during presetting of travel time
- Flexible production e.g. via remote control of supply and exhaust air flow

Digitalisation for reduced complexity

- No need for lots of additional components thanks to digital function integration
- Product key as a digital copy

Standardised networking, data-based decisions

- OPC UA using the automation platform CPX
- Preventive maintenance using condition monitoring apps such as “Leakage diagnostics”

Make the most of process advantages along the entire value chain

The digitised pneumatics of the Festo Motion Terminal usually pay off quickly – along the entire value chain. The benefits range from faster planning and design to simpler procurement and logistics, as well as easier commissioning and parameterisation. More productive operation and the ability to quickly and easily convert or modernise your system will also speed up the return on investment.

Flexible and economic down to a batch size of 1 – get to pole position with just a few clicks!



Enjoy maximum flexibility and stand out from the competition: changes to requirements during the design or operation of a system will soon be child's play. With the Festo Motion Terminal, you can change functions and process parameters easily at the click of a mouse – with no increase in costs for subsequent modifications.

You will also save a huge amount of time – up to 60% – during operation, as you will be using fewer components and no longer need to carry out manual adjustments.

Reliable processes – protected knowledge! Digital function integration is the key

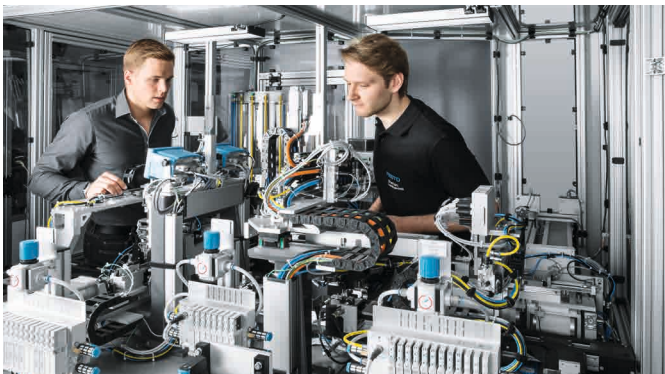

Increase your process reliability: with the Festo Motion Terminal, you can set up your pneumatic systems to ensure absolute reproducibility, make your modifications transparent and prevent manual tampering. Last but not least, you can also protect your design knowledge, as the digital functions remain hidden and cannot be determined by looking at the hardware.

Maximum effectiveness throughout the entire system and longer component service life



Benefit from increased availability: the integrated sensors and matching Motion Apps make condition monitoring and diagnostics for accurate preventive maintenance easier than ever before. Motion Apps like Soft Stop also reduce troublesome vibrations, replace wear-prone shock absorbers and reduce cycle times by up to 30%.

Self-regulating Motion Apps, such as Presetting of travel time, facilitate longer operating times in spite of changing parameters, such as increasing wear.

Boost productivity along the entire value chain



The Festo Motion Terminal will increase your profitability – and that of the operator. For instance, you can now proportionally regulate two pressures using just one valve. This saves costs and time.

An integrated approach ensures energy-efficient operation. Low-energy piezo pilot valves reduce current consumption by 90%, while Motion Apps such as ECO drive reduce your compressed air consumption by up to 70%. There's no need for shock absorbers or flow control valves, thus significantly reducing your spare parts usage.

Standardisation and reduced complexity thanks to one valve technology for many tasks



The Festo Motion Terminal reduces complexity and supports maximum standardisation. It now allows 50 different components and a wide range of functions to be packed into one valve. And soon, it will pack in even more! This will speed up your engineering process and reduce the number of different spare parts that the operator needs to keep in stock.

How can the Festo Motion Terminal help you to shape the production of the future?



With the Festo Motion Terminal, your system can still be modernised with new functions or its performance can be improved thanks to digitised pneumatics – no hardware modifications are required. Last but not least, the digitised pneumatics also allows you to create new business models in line with Industry 4.0. Put simply: more data + higher process

quality and information density = new approaches. Let's think about that together!

Areas of application for the Festo Motion Terminal

What areas offer the perfect environment for the Festo Motion Terminal as a pneumatic automation platform? What variants are available? Here are a few application examples. More will follow soon.

Always ready to go: the successful, tried-and-tested electric automation platform CPX. With CPX, you can integrate the fieldbus or Industrial Ethernet nodes you need, plus

additional I/O modules, subordinate installation systems such as CTEL, or CODESYS controllers with an OPC UA interface. The two automation platforms are the perfect partners.

Here is an overview of the available variants:

Platform with 2 valves

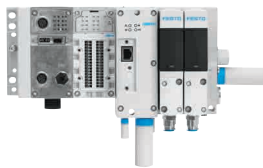

Platform with 4 valves

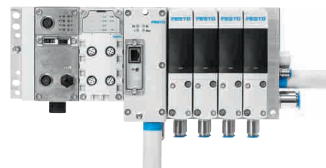

Platform with 8 valves



Position transmitter SDAP



Platform with 2 valves and 1 input module

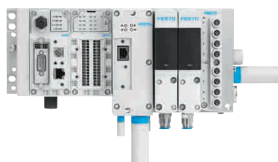

Platform with 4 valves and 2 input modules

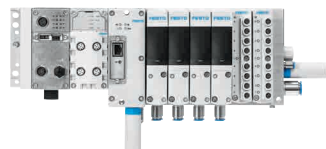

Platform with 8 valves and 2 input modules



Input modules CTMM: analogue and digital



Application examples

1. Pre-positioning, gripping with controlled vacuum and setting down with ejector pulse

Motion Apps: Proportional pressure regulation and positioning (on request). The different formats required for this task often involve adjustments and, depending on the solution used, several components. The gripping vacuum and ejector pulse need to be regulated and checked individually for every format change-over.

The advantages in detail:

- 7 fewer components
- 75% less installation space
- Identical costs with significant process improvements
- Faster format change-over (~20 minutes per change-over), plus always the same settings
- In the future, gripper formats/ reduced cycle times can be easily expanded

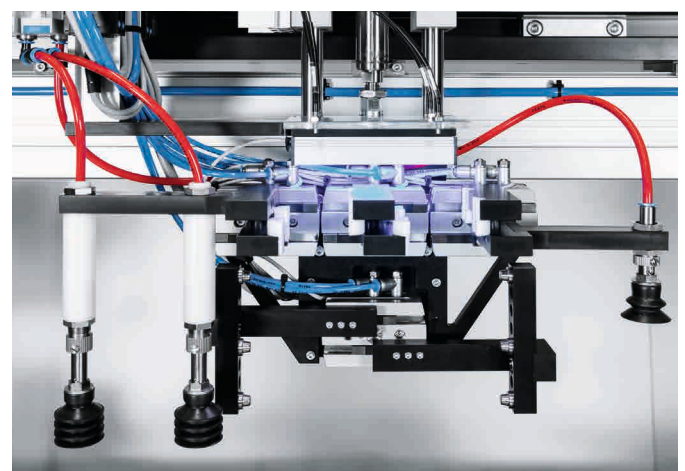

2. Checking the quality of containers: simpler, more cost-effective, more reliable

Motion Apps: Soft Stop, Proportional pressure regulation and Leakage diagnostics. In test set-ups for containers, up to 60 containers per procedure are tested for stability and leak tightness. This requires an even, gentle application of cylinder force with a precise level of force for just a few seconds. The current solutions comprise up to 60 motor controllers, the corresponding sensors, 3/2-way valves and electric cylinders. But the Festo Motion Terminal VTEM can now complete this task in combination with pneumatic cylinders DSBC and position transmitter SDAP.

The effect

Fewer components – greater reliability. 8 Festo Motion Terminals replace up to 64 electric cylinders.

The advantages in detail:

- 70% lower costs compared to an electrical solution
- 65% less installation space required
- 85% reduction in costs for wearing parts
- Controlled movement and leakage detection using the same components

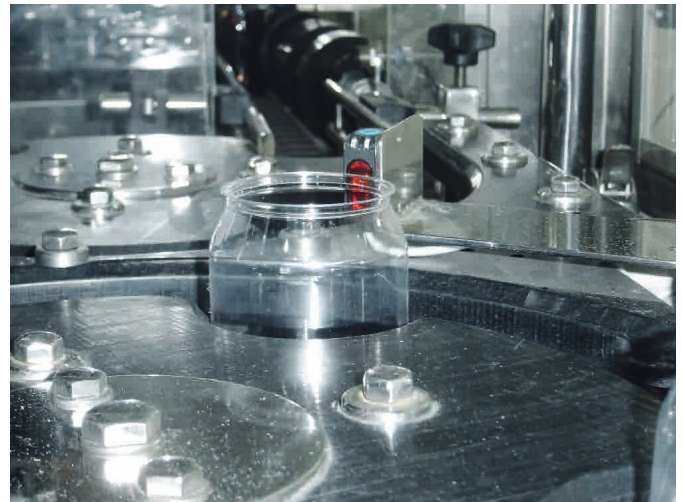

What's your application?

The Festo Motion Terminal can replace over 50 components without any problem. This opens the door for new approaches to a wide range of applications, such as an adaptable pneumatic platform for handling units with many different grippers. The Festo Motion Terminal is also perfectly suited to continuous processes where the travel time of the pneumatic actuator is crucial to process quality and additional processes can be self-regulating.

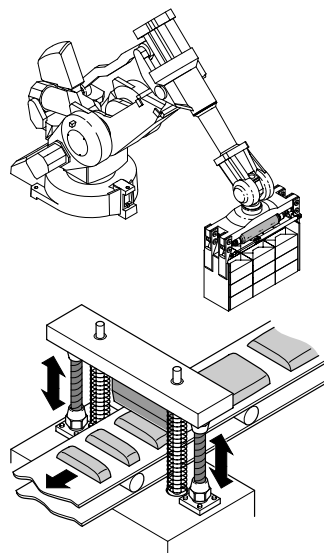

Over 50 components in one valve

- 18 directional control valves (9 directional control valves in 2 sizes)
- 8 pressure sensors (ducts 1, 2, 3/5, 4; with 2x 3/2-way valves)
- 6 pressure regulators (ducts 2, 3/5, 4 with 2 sizes)
- 5 components for previous Soft Stop applications
- 4 flow control valves (2x supply air, 2x exhaust air)
- 3 proportional flow control valves (4/3 and 2x 3/3)
- 2 proportional pressure regulators
- 2 shock absorbers
- 2 external sensors (model-based proportional pressure regulation)

8 questions that will quickly tell you whether the Festo Motion Terminal VTEM can help you

1. Do I use more than 2 proportional valves in my application?
2. Can I avoid the use of shock absorbers?
3. Can I save more than 70% on cylinder travel time?
4. Do I need an even application of force with deviations of less than ± 3 N?
5. Do I combine movements with controlled force in intermediate positions?
6. Do I want to significantly reduce the number of components installed in my machine?
7. Do I want to automate my system energy-efficiently?
8. Do I want to avoid hybrid solutions, and focus on just one technology instead of using pneumatic components for vacuum and electric ones for motion, for example?

If you answered “yes” to one or more of these questions, then it’s worth taking a look at the Festo Motion Terminal VTEM.

The technical data at a glance

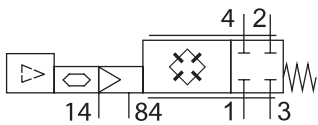
The technical data at a glance	
Fieldbus/Industrial Ethernet nodes via the CPX terminal	PROFIBUS DP, PROFINET, EtherCAT, Ethernet/IP, DeviceNet, CC-Link, Powerlink, Sercos, Modbus/TCP
Other CPX modules	Various I/O modules CPX-CEC-C1-V3 for CODESYS embedded control with OPC UA CTEL for subordinate installation systems
Valve functions  (circuit symbol for all functions)	Can be allocated using the Directional control valve functions Motion App: 2x2/2 C; 2x3/2 C; 2x3/2 O; 3/2 O +3/2 C; 4/2, 4/3 C; 4/3 P; 4/3 E C= closed; O= open; P= pressurised; E= exhausted Other Motion Apps: Proportional directional control valve, Proportional pressure regulation, Model-based proportional pressure regulation, Leakage diagnostics, Supply and exhaust air flow control, ECO drive, Presetting of travel time, Selectable pressure level, Soft Stop
Motion Terminal input modules CTMM	Analogue/digital, each with max. 8 inputs per module
Grid dimension	28 mm
Standard nominal flow rate [QnN]	480 l/min
Maximum number of valve positions	2, 4 or 8 Ventile
Valve switching time	8,5 ms
Manual override	Using WebConfig via Ethernet interface
Lubrication	NSF-H1 (silicon based)
Grade of filtration for compressed air used	40 μ m
Suitability for vacuum	Yes
Operating pressure	-0.9 ... +8 bar with ext. pilot air
Pilot air	Internal or external
Pneumatic port 2 and 4	G1/8
Pneumatic port 1 and 3	G3/8
Degree of protection	IP65
Operating voltage	24 V DC \pm 10%
Ambient temperature	+5 ... +50°C

Save energy: new approaches to energy efficiency

The technology of the Festo Motion Terminal uses an integrated approach to energy-efficient operation of pneumatic automation technology. The terminal includes low-energy piezo valves in the pilot stage, specially developed Motion Apps for energy-efficient operating modes, and a leakage diagnostic function.



Basic low-energy technology

The low-energy piezo valves reduce the energy consumption for the pilot control stage by up to 90% – with a pilot valve service life of up to 300 million switching cycles.



Apps for energy-efficient operation

The Motion Apps “ECO drive” and “Selectable pressure level” will allow operators to control their systems more selectively in the future. The “ECO drive” Motion App alone will generate savings of up to 70%. More apps will follow.

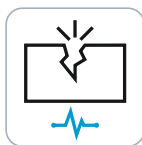

One app for leakage detection

The “Leakage diagnostics” Motion App enables the status of pneumatic systems connected to the Festo Motion Terminal to be continuously monitored, thus ensuring that leakages are detected early.

How the ECO drive Motion App works

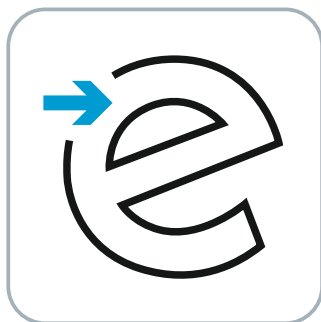

By controlling the flow of supply air, this Motion App keeps the pressure in the drive during movement to the minimum required by the load and advancing speed. If the load to be moved changes, the pressure is automatically increased or reduced. The proximity sensor detects when the end position

has been reached and the Motion Terminal shuts off the air supply.

This prevents unproductive further pressurisation at the supply pressure level, but also means that the force cannot be increased above the minimum required. This Motion App is therefore not

designed for pressing and holding functions in the end position.

That's how easy it is to save money with the “Selectable pressure level” Motion App

As the pressure level for every movement can be specified digitally with the “Selectable pressure level” Motion App, you can now easily adjust the pressure to suit every application. Check whether you really

need to use the maximum pressure level for all your automation tasks!

~€400 in 2 years

-27%

↑ 6 bar
↓ < 2 bar

Digital simplicity: maximum flexibility combined with maximum standardisation

For the first time ever, the functions of a valve can be controlled and changed by software – without the need to change the hardware. This completely new, intelligent technology consisting of pneumatics, electronics and software control can be used to realise a wide range of functions, from simple directional control valve functions through to complex motion tasks. It also allows you to realise functions such as status monitoring and reduced energy consumption with far fewer components than before. In addition, some Motion Apps can automatically adjust to changes in parameters. That's what we call **digital simplicity**.

